

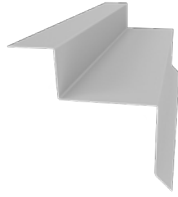

Required Trims
Rake Bracket

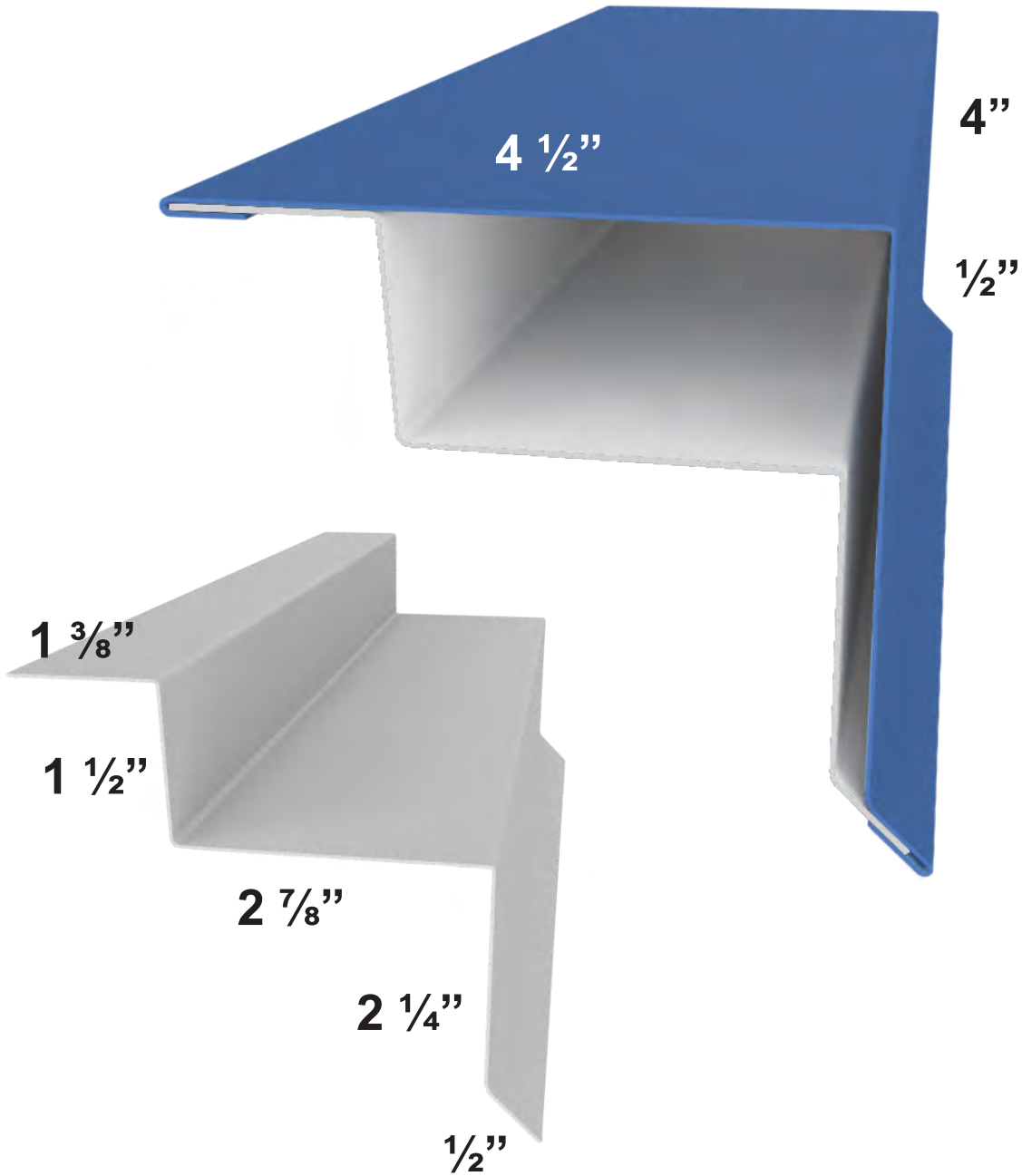

Rake



4

Trim

Drip Edge

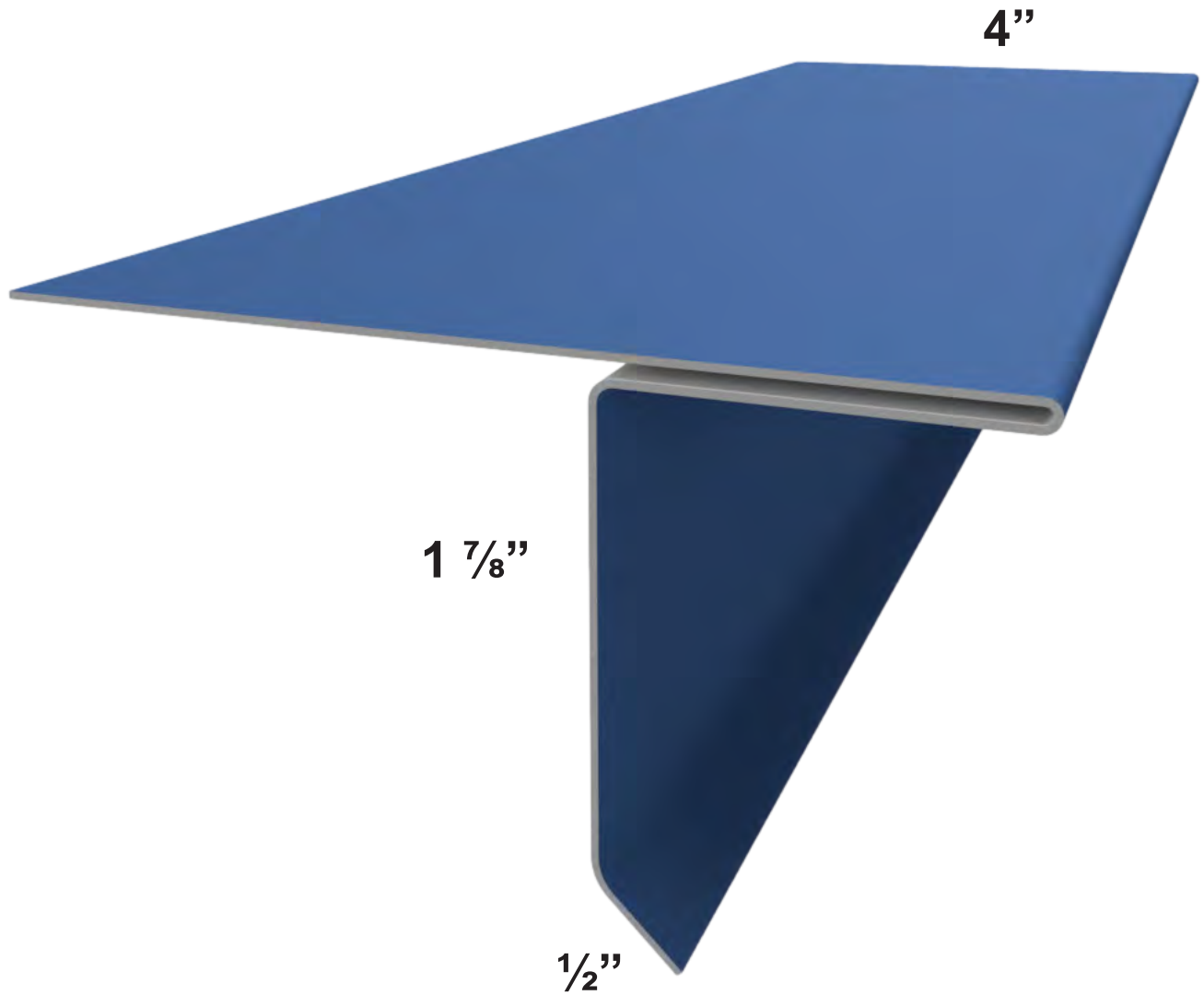

Bending Bar/Hemming Tool

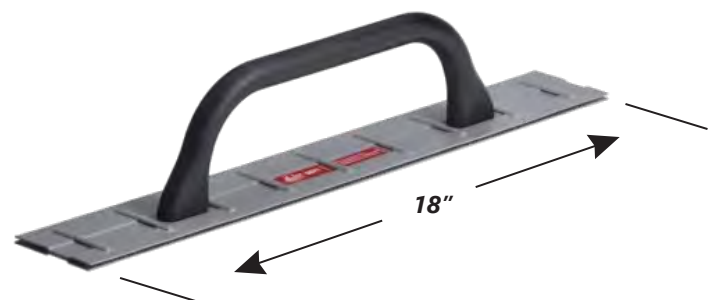

Trim



Flat Sidewall

Required Trims
Z Closure

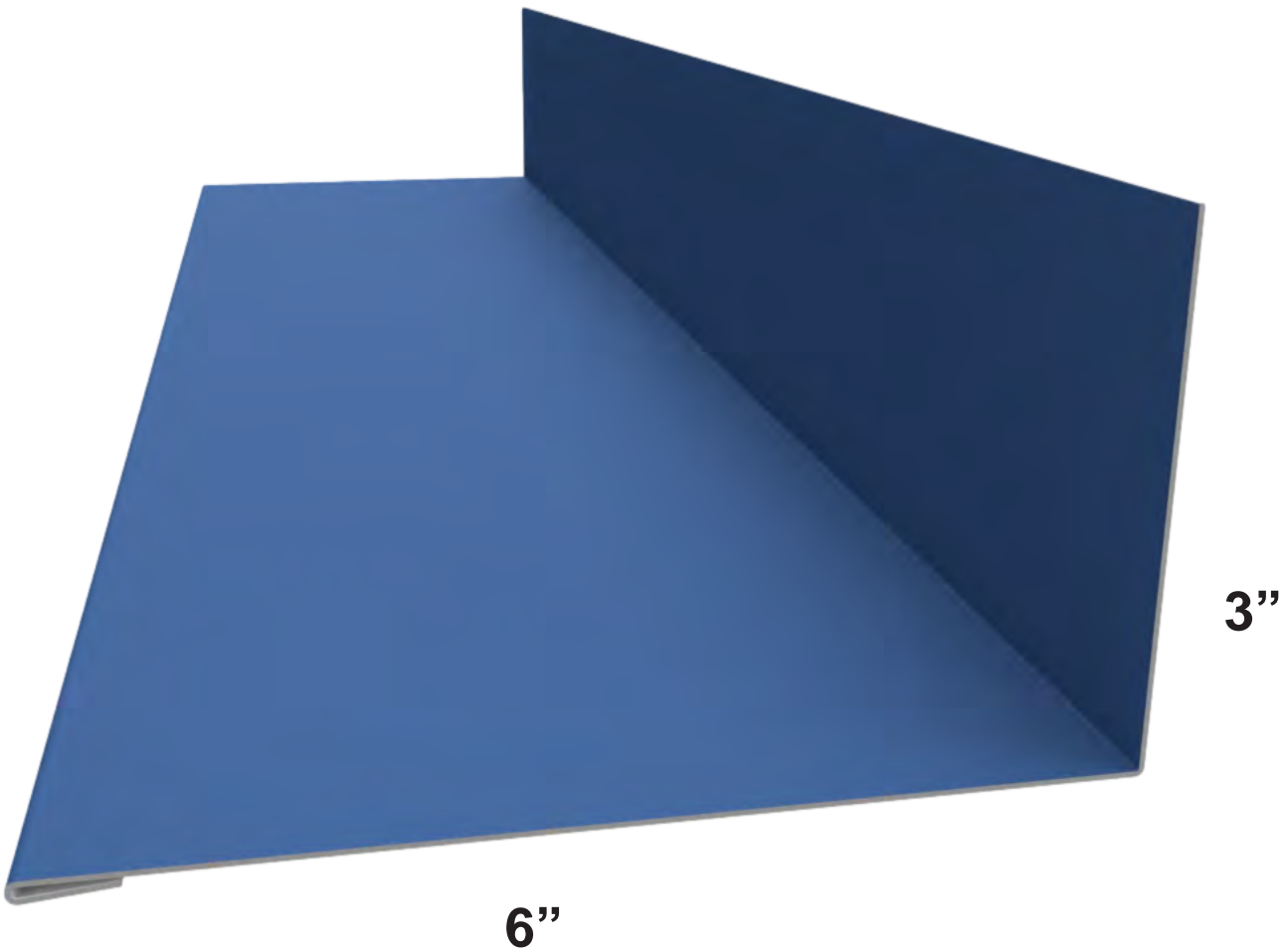
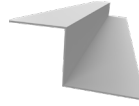

Required Trims
Cleat Offset

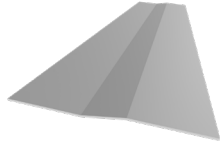

Valley

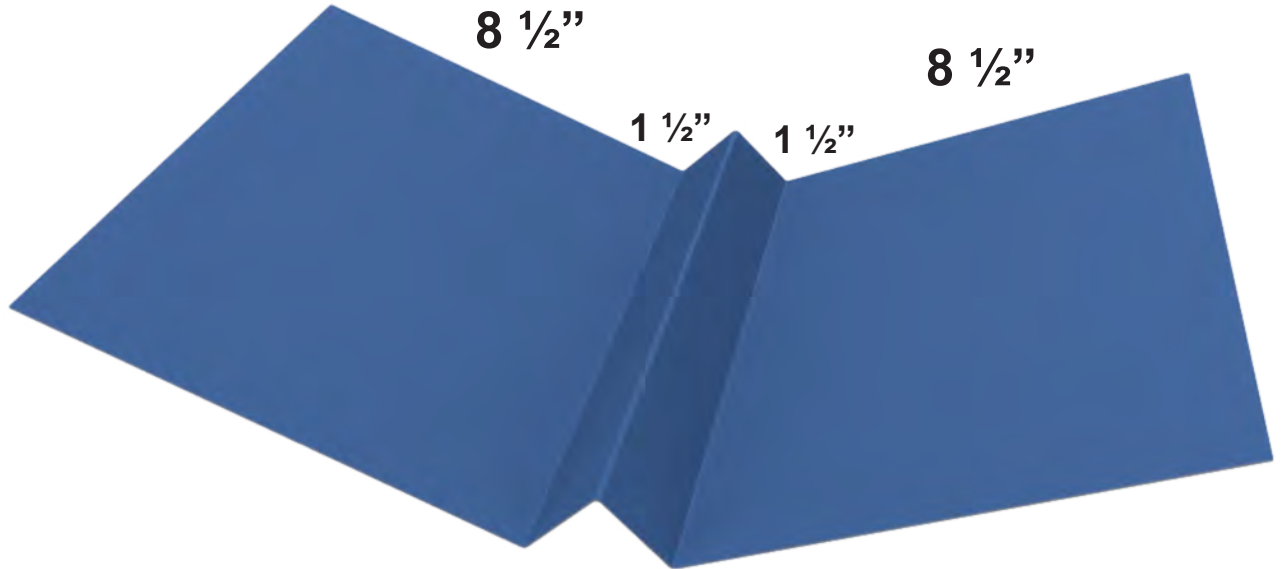

Bending Bar/Hemming Tool

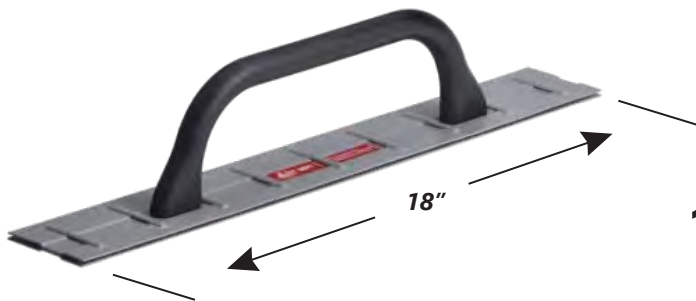

Cleat Offset

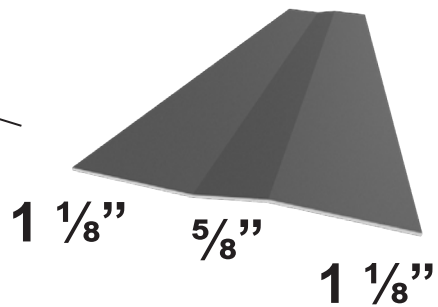

Trim



Flat Ridge Cap

Required Trims

Z Closure

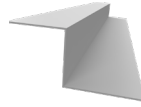

OR

Snap Vent

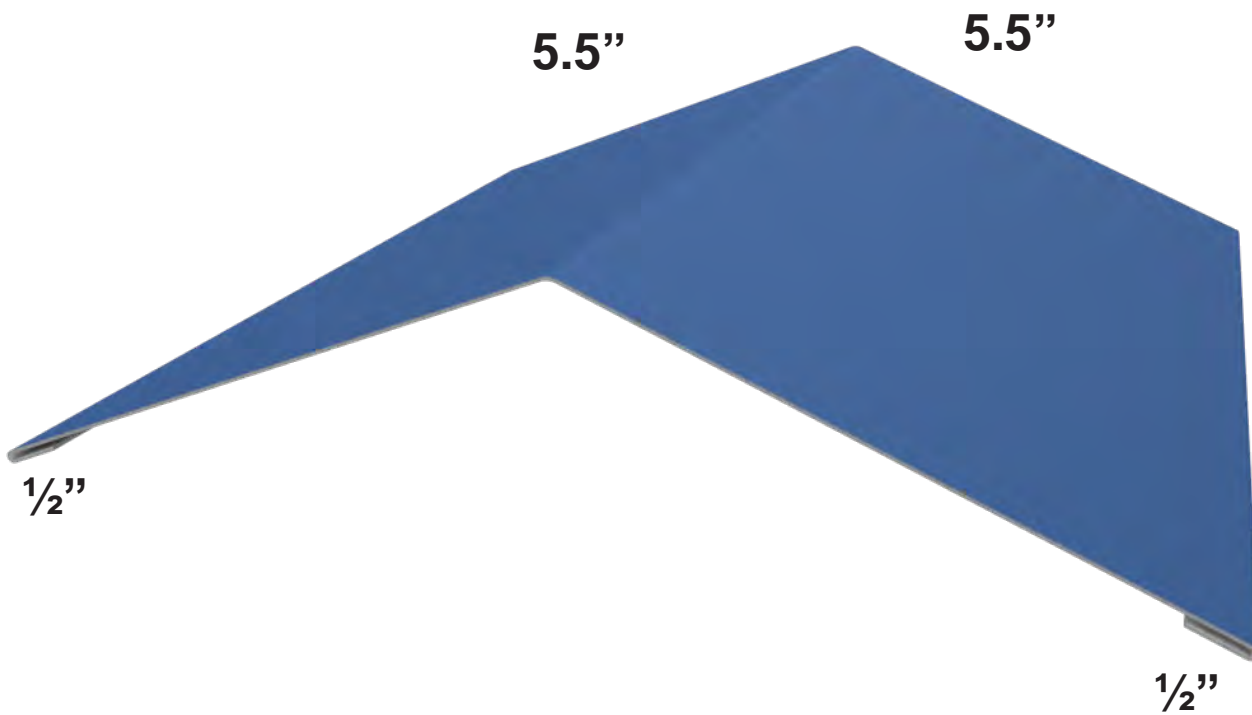

Trim List

PROFILED HIP/RIDGE (Stock 26 ga.)

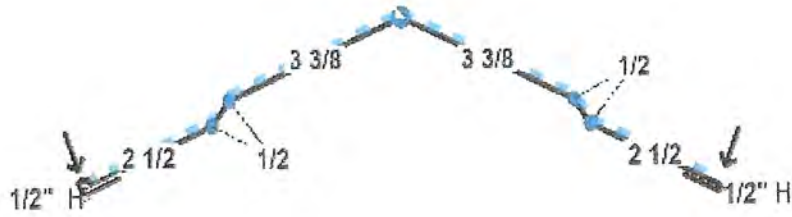

5X5 FLAT RIDGE



6X6 FLAT RIDGE (Stock 26 ga.)



941-600-2521

719 Cattlemen Road
Sarasota, FL 34232

TILE VALLEY (Stock 24 ga.)



5" HIP RISERS

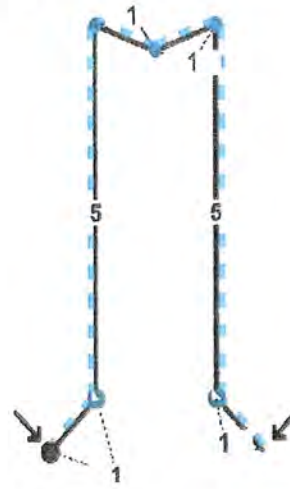

4" HIP RISERS

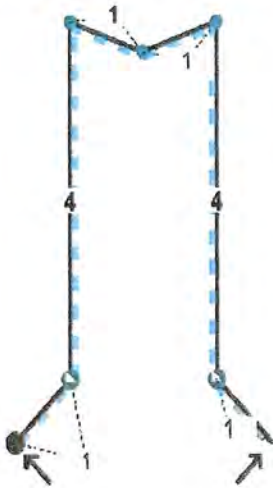

6" HIP RISERS

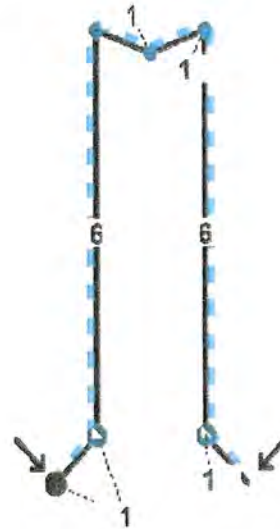

PROFILED SIDE WALL FLASHING

(Stock 26 ga.)

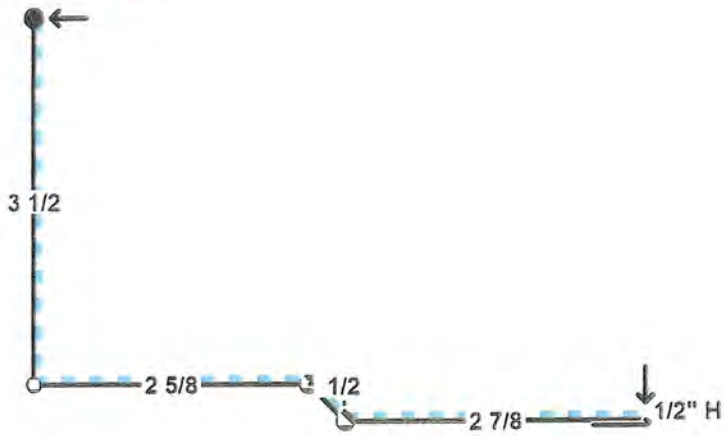

ABOVE DOOR TRIM

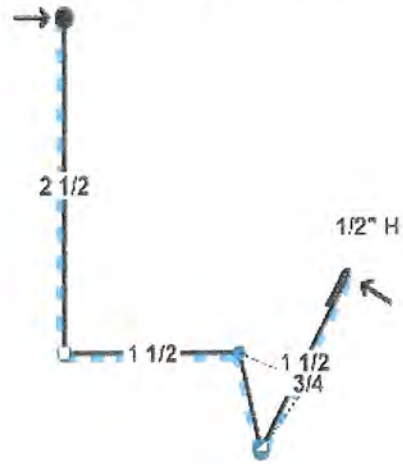

COUNTER FLASHING #1 (Stock 26 ga.)

FLAT SIDE WALL (Stock 26 ga.)

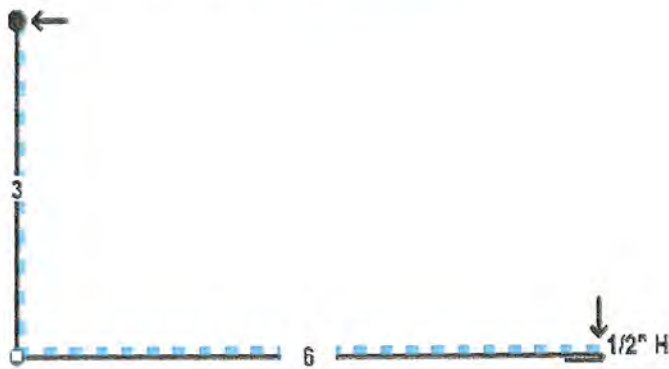

L FLASHING (Stock 26 ga.)

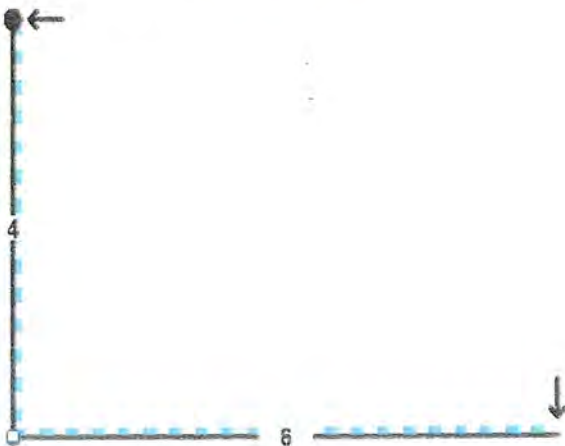

COUNTER FLASHING #2



Gravel/Stucco Stop



5-V/SunRib J-Channel

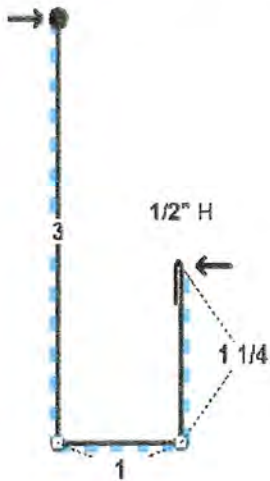

PBR J-Channel

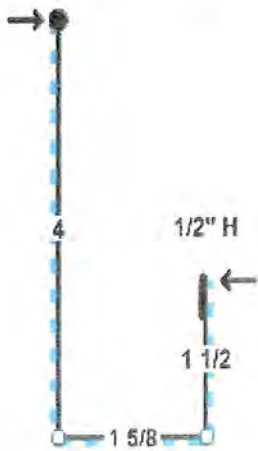

Fascia Cover #1

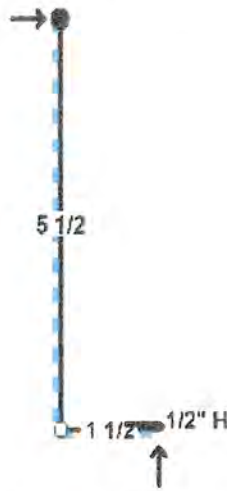

Fascia Cover #2

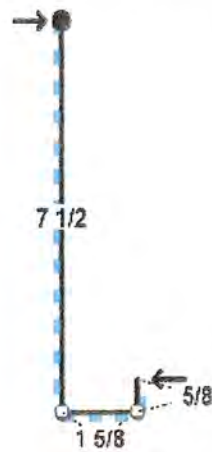

4x4 SunRib/5-V Crimp Corner (Stock 26ga.) **4x5 Corner**

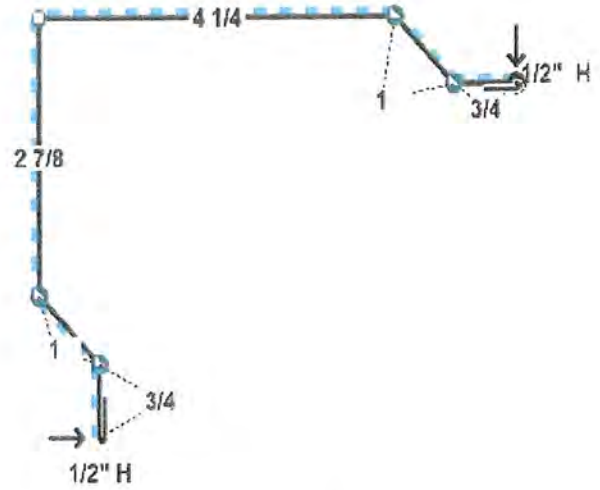
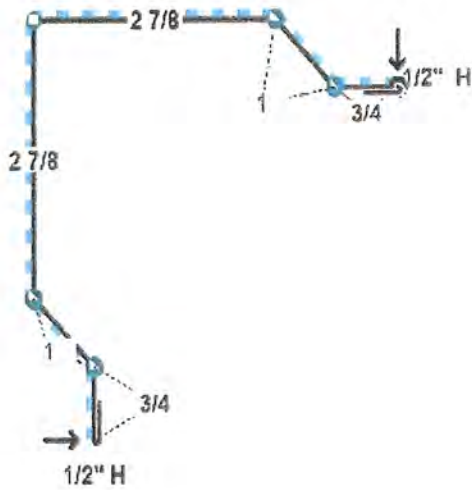

6x6 PBR Corner (Stock 26 ga.)

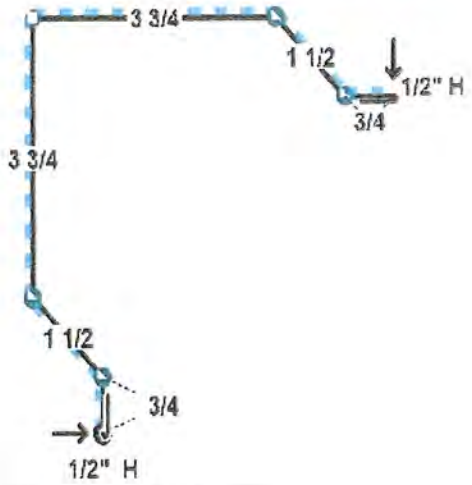

Corner/Drip Edge (Stock 26 ga.)

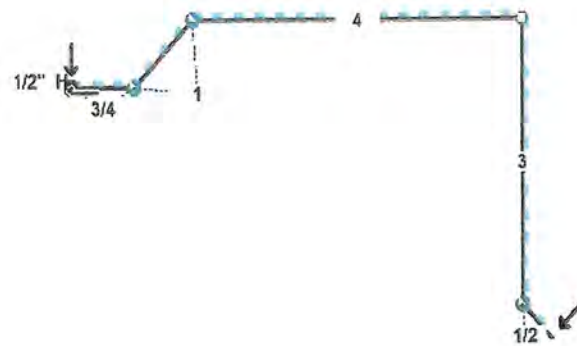

Corner Clip Z

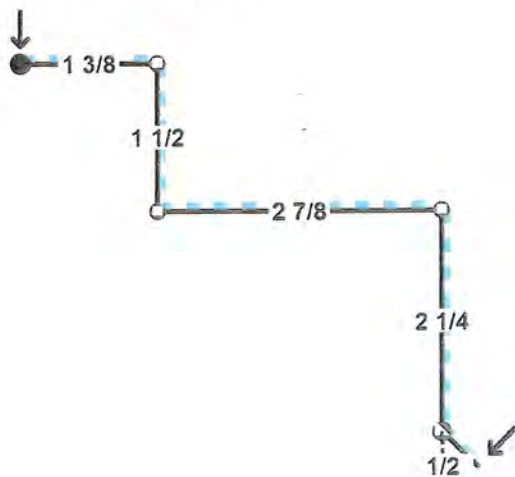

Standing Seam Corner

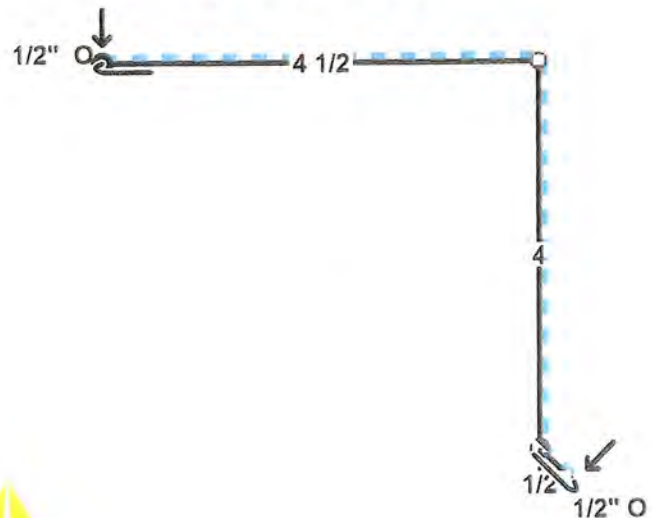

6" Drip Edge Metal/Aluminum (Stock 26 ga.)

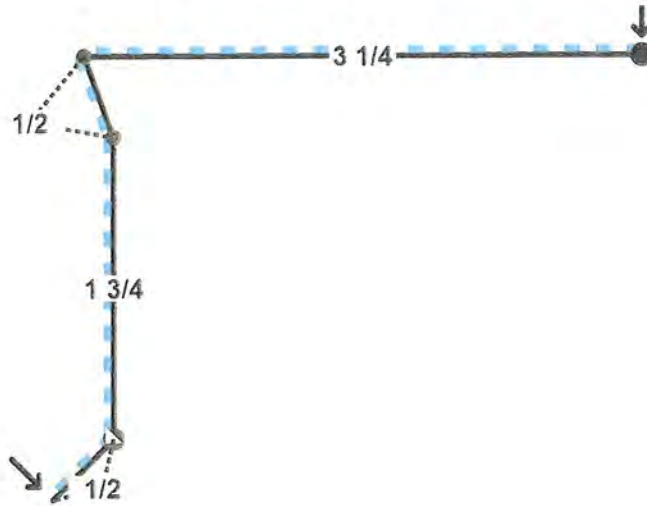

5" Drip Edge Aluminum (Stock .027 White)

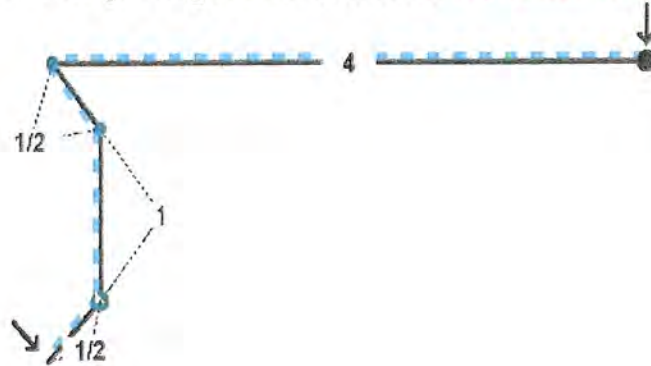

SnapLock Drip Edge (Stock)

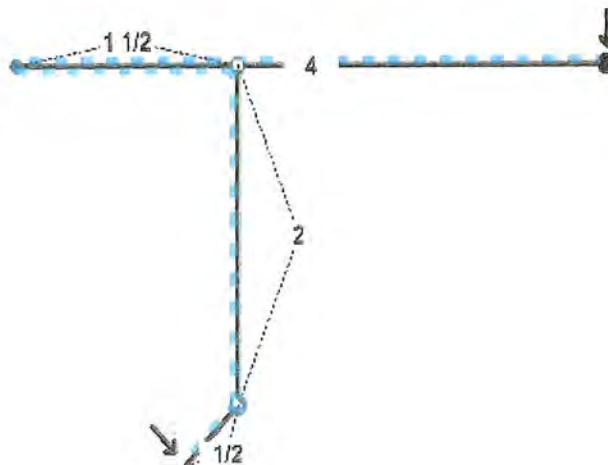

5-V & SunRib Valleys (Stock 26 ga.)

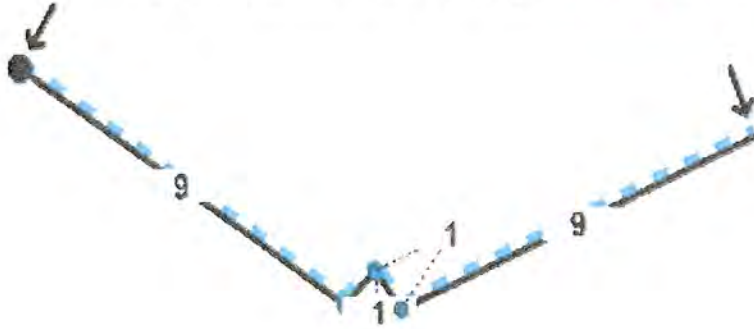

SnapLock Valleys (Stock 24 ga.)

